

# TEVERUN FIGHTER MANUAL



NINGBO TEVERUN TECHNOLOGY CO.,LTD.

Add:Xiwang Industry Zone,Hengjie Town, 315181,Ningbo,China  
Email:info@teverun.com  
Web:www.teverun.com

# CONTENTS

|  |     |
|--|-----|
| Safety guidelines and restrictions .....     | P2  |
| Product structure.....                       | P4  |
| Name of parts .....                          | P5  |
| Product unfolding .....                      | P6  |
| Product folding.....                         | P6  |
| Lock handle bar.....                         | P6  |
| TFT display instruction .....                | P7  |
| How to use the charger correctly.....        | P15 |
| Safety precautions for Lithium battery ..... | P16 |
| Safety guidelines before driving .....       | P17 |
| Check and maintenance .....                  | P18 |
| Important check list .....                   | P20 |

## Before Reading the Manual

This manual contains important information to help you to use your product more safely. For your safety, there are warnings of 'Danger', 'Warning', and 'Caution' depending on the degree of danger and the meanings are below.



**DANGER** Indicates a hazardous situation that will result in serious injury.



**WARNING** Indicates a hazardous situation that could result in serious injury.



**CAUTION** Indicates a hazardous situation that could result in minor or moderate injury.

## Before Reading Manual **CAUTION**

**✓ Please read this manual carefully**  
before using this product

### 1) General safety guidelines and restrictions

\* Even if the it is within the warranty period, you may be liable for any accident caused by any of the following causes.



#### 1. Be careful of water!

This product and components are not waterproof. Don't let the water get into the product and components.

\*Never use it, if the road is wet due to the rain, snow, hailstone.

\*If you wash or spread water to electric devices, it can result in malfunction or fire.

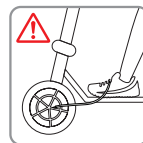

#### 2. Beware of folding and spinning parts!

If parts of the body, as a finger or hair, get caught in the spinning or folding parts of the product, this may lead to severe injuries. Please be careful.



#### 3. No acrobatics

Stunts and jumps such as jumping and dropping are prohibited as they can cause a great impact on the product and can cause of malfunction and accidents.

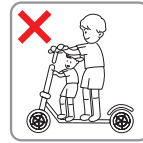

#### 4. No companion boarding

This product is intended for one adult only, so children, infants, or two people are prohibited from boarding.



#### 5. Don't tune by yourself

Do not open or tune the electric parts (battery, controller or motor system).

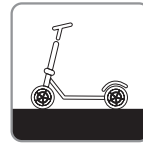

#### 6. No companion boarding

Unlicensed, driving after drinking, loading cargo on the scooter is prohibited. (More than bike or bicycle license is required) Please comply with the Road Traffic Act and related laws and regulations according to the place of use.

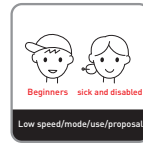

#### 7. Beginners and seniors are encouraged to use at low speed

Beginners who are not accustomed to use the product, seniors and others should avoid high speed mode driving and recommend low speed driving. In addition, please use after practice how to ride safely in a wide place.



#### 8. Do not sudden brake with front brake

If there is a risk of overturning, sudden deceleration should be done safely. Do not apply any unusual behaviors or artificial forces, such as stopping with your feet.



### 10. Do not drive on steep slopes

Acceptable gradeability is different for each product. Excessive hill roads exceeding the specification may cause damage to the product (parts) due to temperature cut, overcurrent, or low voltage cut, which may cause the product to malfunction.



### 11. Safety warning when lifting the product

Please always lift the product with at least one other person. When lifting the product, please be careful not to damage your back or knees.



### 12. Be sure to wear safety equipment

For the safety of passengers, be sure to wear a full face helmet and the other protective gear (for knees, elbows, hands, upper body) and do not wear shoes such as slippers or high heels that can interfere with driving.

## 2) Precaution before driving

1. Night driving should be avoided at all times. Always wear helmets and other body guards and drive safely.
2. Select the mode that suits you and drive. In order to cope with sudden situations, be prepared to slow down by holding the brake at all times.
3. When turning left / right, slow down to avoid the danger of overturning or slipping, then slowly turn safely.
4. To go backwards safely, get off the product only after coming to a complete stop.
5. It is prohibited to use in any places that are slippery, crowded, have a steep slope, or are uneven.
6. When crossing a pedestrian crossing, get off from the product for pedestrian safety.
7. Do not drive in a way that threatens any other means of transport, such as animals, pedestrians, bicycles, motorcycles, cars, etc.
8. When passing speed bumps and road obstacles, be sure to slow down.
9. When decelerating or braking, do not stop with your foot, but by using the brake appropriately.
10. Be careful as there is a risk of burns due to heat from the motor and brake (especially disk rotor) after driving.
11. It is prohibited to drive by holding the handle with one hand; please use both hands at all times.
12. Do not ride or drive when the kick stand is down.

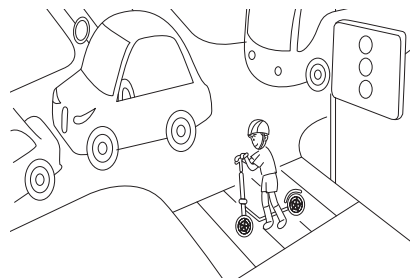

## Product structure

### Scooter size



### Handle bar

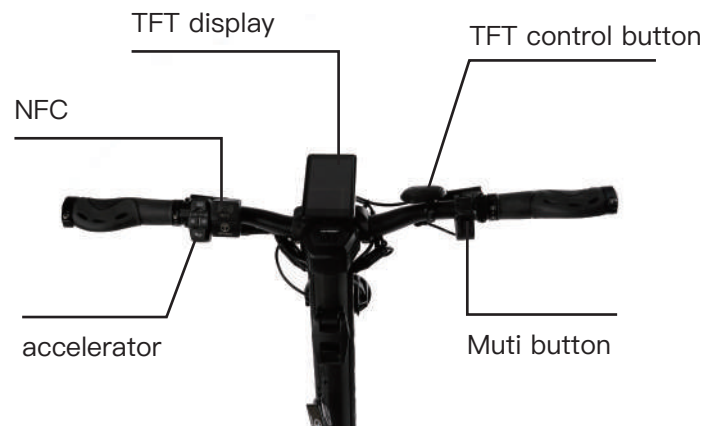

## Name of Parts



05

## Product unfolding



## Product folding

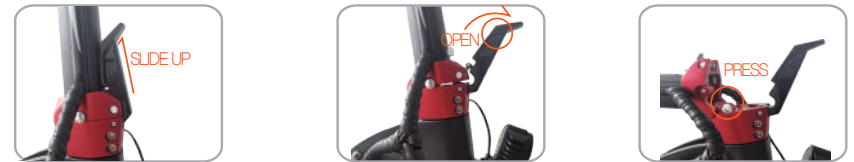

## Lock handle bar



06

## TFT display instruction



## Introduction

- 5.1 Screen size: 3.5inch color TFT screen.
- 5.2 Kilometer / Mile: Can be set according to customers' habits.
- 5.3 Intelligent power indicator contains below: It can provide a stable power indication through the optimization algorithm. The power is not affected by the start-stop fluctuation of the motor. If the system supports battery communication, the accurate percentage of power will be displayed.

- 5.4 Adjusting 5 levels backlight brightness: 1st level is the darkest, 5th is the lightest.
- 5.5 ECO and 1-5 levels: Can be set according to customers' habits.
- 5.6 Mileage indicator: Odometer/Trip distance/ Riding time.
- 5.7 Clock display: inner small battery, keep time when the display is closed
- 5.8 Power indicator: Real time power indicator, digital or analog.
- 5.9 Error code indicator.
- 5.10 Speed limit adjustment function: total speed limit and gear speed limit can be set.
- 5.11 Current limit adjustment function
- 5.12 USB charging port: provide rated charging for mobile devices. Current: 500mA/5V.
- 5.13 Software upgrade: Software can be upgraded through UART.
- 5.14 Speed measurement magnets (number of pole pairs) adjustment function: the number of speed measurement magnets (magnetic poles) can be set.
- 5.15 Level parameter setting: you can set the parameters of the levels.

## TFT screen instructions

Information:

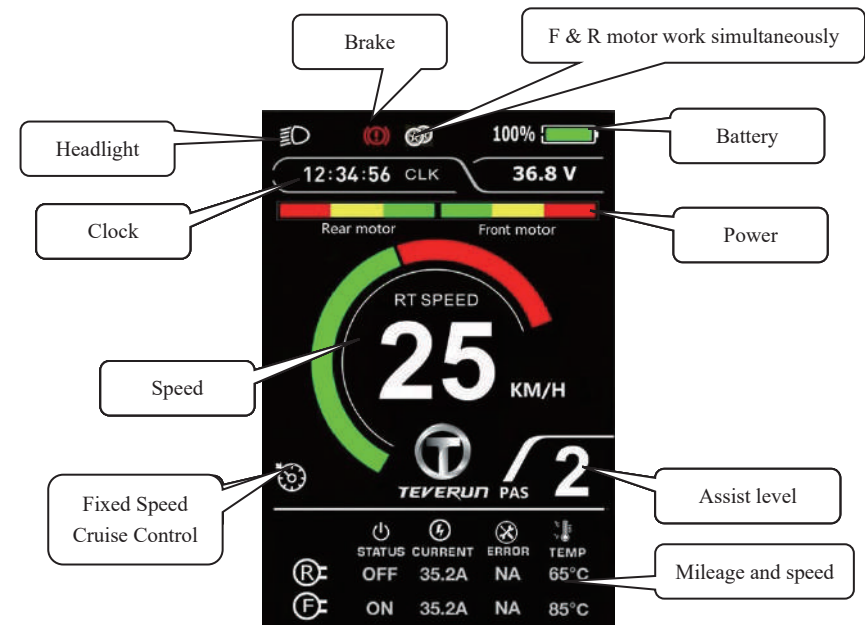

Status:

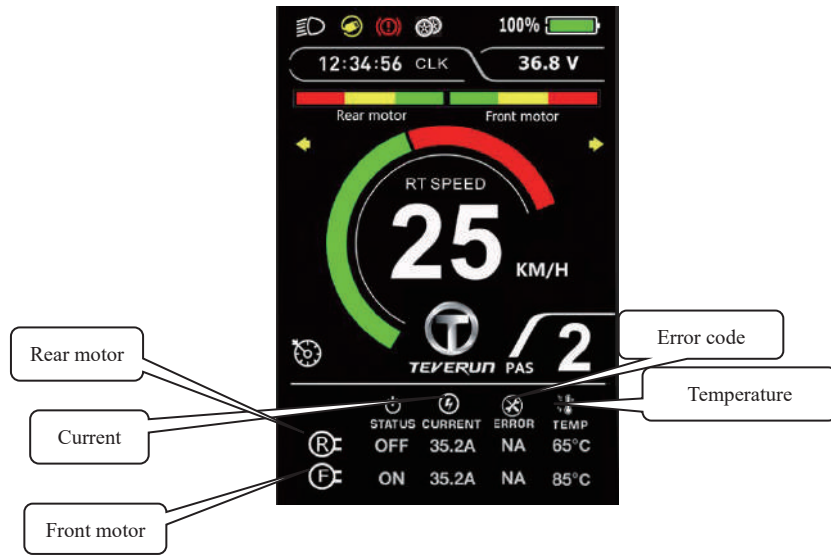

**6.1 Display interface:** The default value is information mode, click M key to switch to the status interface

**6.2 Speed model:** AVG SPEED/MAX SPEED/RT SPEED

**6.3 Headlight indication:** When the headlight is working, showing

**6.4 Brake indication:** When the brake is working, showing

**6.5 Assist level:** showing current assist levels

**6.6 Speed indication:** Km/h or MPH

**6.7 Clock information** can be displayed.

**6.8 Real-time current information** can be indicated.

**6.9 Motor status** can be indicated: ON and OFF.

**6.10 Error code** can be displayed. Please refer to the common error code.

| Error code                               | Error descriptions          |
|--|-----------------------------|
| “1” is shown at the bottom of the screen | Motor is out of phase       |
| “2” is shown at the bottom of the screen | Hall fault                  |
| “4” is shown at the bottom of the screen | Handlebar fault             |
| “5” is shown at the bottom of the screen | Under voltage protection    |
| “6” is shown at the bottom of the screen | Controller fault            |
| “7” is shown at the bottom of the screen | Communication error         |
| “8” is shown at the bottom of the screen | Over-temperature protection |

6.11 Real-time temperature can be indicated.

## Functional Description



### 7.1 Power On/Off

Press and hold Power button for 1 second, it can turn on/off the display. The display will automatically shut down when there is no operation & ride for 10 minutes (time interval can be set) .

**\*If the display has been set power-on password, you need to input the right password when starting.**

### 7.2 Assist Level Operating

Short press UP/DOWN button can change the assist levels. Available assist levels include ECO, 1,2,3,4 and 5.

### 7.3 Headlight/Display Model Change

Press and hold UP button for 1 second, the backlight brightness will be lowered and headlight will be on (controller support is needed). At the same time, switching daytime/night mode. Press and hold UP button for 1 second again, headlight will be off and change the display mode.

**\*The backlight brightness has 5 levels and users can adjust it according to their demands.**

### 7.4 Data Cleanup

Pressing and holding UP & DOWN buttons concurrently for 1 second can reset temporary data, including AVG Speed / MAX Speed / Trip / Time.

**\*These temporary data will not be erased when power is off.**

## MENU Parameter Setting

In the state of power on, press the M button twice (time interval must be within 0.3S), the system will enter the parameter setting menu. Press M button twice again to exist setting state (time interval must be within 0.3S).

In the MENU setting interface, press M button to confirm and press POWER to cancel. Press UP or DOWN to select the adjusting items. Press M button, the parameter to be set will be blinking. If you want to adjust related parameters, please press UP or DOWN. Then press M to save and press POWER or select EXIT to back to the main menu. In the function selection interface, press M button twice consecutively or select EXIT to exit menu.

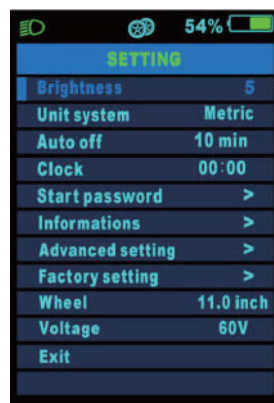

Function select menu

**8.1 Brightness:** Press M button to enter the setting menu. Adjusting the brightness 1-5 by pressing UP/DOWN button. 1 is the darkest, 5 is the brightest. Press M to confirm and return to the main menu.

**8.2 Unit system: Metric/Imperial**

**8.3 Auto off:** Press UP/DOWN button to change the auto power off time. The number from 1 to 10 represents time (minutes) to shut down and the default value is 10 minutes. Please press M to confirm or press POWER to cancel the settings.

**8.4 Clock:** Press M button to enter the clock setting menu. Press UP/DOWN button to set Hour/Min. Please press M to confirm or press POWER to cancel the settings. After setting the parameters, please press M to confirm and return to the main menu.

**8.5 Start password open and set:** Press M button to enter password setting interface. Select ON/OFF to turn on or off the start password. Select Reset the Password to enter the new password setting interface. Select Back or press the POWER button to return to the main menu. the default password is "0000".

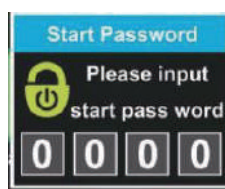

enter the password

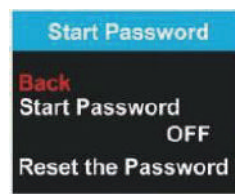

selections

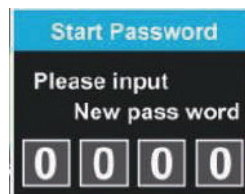

enter the new password

**8.6 Information:** Press M button and choose Information to enter information menu. It will shows speed mode and mileage mode information. After finish setting, press M button or POWER to choose return to main menu.

| Information      |          |
|------------------|----------|
| AVG Speed        | 10.5km/h |
| Max Speed        | 65.7km/h |
| Trip             | 123.8km  |
| ODO              | 5832km   |
| Hardware version | 2.0      |
| Software version | 1.1      |
| Exit             |          |

Information display

**8.7 Advance setting:** Press M to enter into Advance Setting interface and press UP/DOWN to adjust the password and enter the advance setting. Input right password to enter the submenu. The password is 4 digits and the default value is "2112". If the power-on password is turned on, the advanced setting password is the power-on password. The options and functions are as follows.



☆Speed limit→\*\*%

☆Cruise→OFF/AUTO/MANUAL

☆ABS ON/OFF

☆Speed magnets number:1-88

☆Assist level parameter:

Assist1/ Assist2/ Assist3/ Assist4/ Assist5 parameters can be set.

| ASSIST 1      |     |
|---------------|-----|
| Speed limit   | 20% |
| EABS level    | 1   |
| F start level | 1   |
| R start level | 1   |
| F current     | 15  |
| R current     | 15  |
| Exit          |     |

Speed limit: 1-100%

EABS level: 1-5

F start level: 1-5

R start level: 1-5

F current is limited

R current is limited

☆Export→NO/YES.

When the switch is on, the speed is limited to 25% and non-zero start.

☆Temp protection: 80-155°C

☆Zero start→N/Y

☆Select Exit or POWER button to return to the main menu.

**8.8 Factory Setting:** Enter Factory settings menu. Select YES will restore all parameter to factory settings.

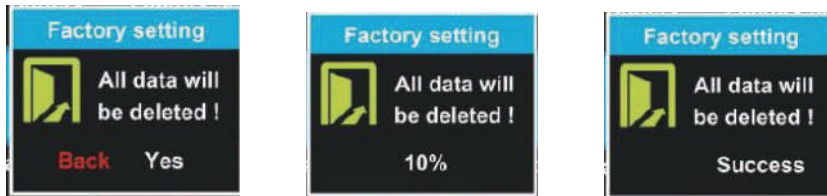

Factory setting

**8.9 Wheel size setting:** Press UP/DOWN button to switch wheel size: 8-14 inches. Wrong wheel size selection will lead to abnormal speed. Press M button to confirm current setting or press POWER button to cancel current setting.

**8.10 Voltage**

**Power system:** 48V/60V/72V

**8.11 Exit**

## Assembly instructions

**9.1** Please pay attention to the screw's torque value. Damages caused by excessive torque are not covered by the warranty.

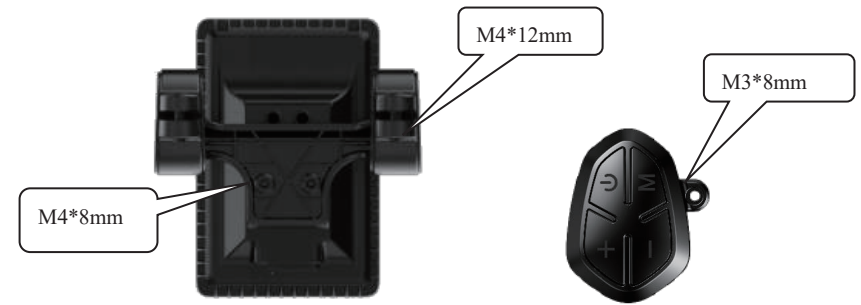

**9.2** Clamps are suitable for 3 sizes of handlebar, 31.8mm, 25.4mm, and 22.2mm. Customers can choose according to their own demands. Handlebar of 25.4mm and 22.2mm must be assembled with the corresponding adapter rings.



Gasket installation diagram



## How to use the charger correctly

### 1) Basic charging method

1. Open the charger port cap and connect it to the connector of the charger and connect it to the household outlet.
2. Charging status indicator
  - (Red) Charging
  - (Green) Charging complete
3. Be sure to close the charger port cap when driving or storing except when charging.
4. When connecting the connector to the charger port, there may be metallic sparks due to voltage difference, but this is normal.

3P charger connector  
(Handle part 1ea)

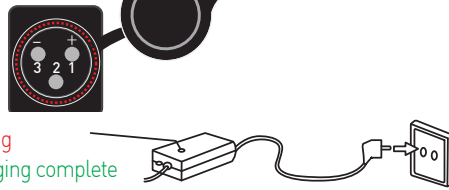

### 2) Basic charging method \* Failure of the charger and abnormal conditions can cause electric shock and fire. Learn the correct usage and prevent safety accidents in advance.

|  |  |   |  |
|--|--|---|--|
| 1. Manufacturers and sellers are not responsible for any problems arising from any disassembly, modification, or mixing with other chargers.   |  | 2. The charger is forbidden to be used in places subject to high humidity, heat, flammable materials, confined spaces, or where there is no ventilation such as in a car. |  |
| 3. The charger is not waterproof. It is thoroughly controlled to prevent moisture from entering the charger.   |  | 4. Children and pets should not be allowed to approach the charger when they come into contact with them, as they may cause an electric shock.                            |  |
| 5. If the charger lamp does not light, charger fall down, strong external shock, long time charge, or cable cover damage, discontinue use immediately and contact the service center |  | 6. Unplug the charger when you are away from the home for long periods.   |  |

7. Use only genuine charger.
8. Do not insert conductors into the charging port.
9. Do not touch the plug for about 10 seconds after unplugging the charger. There is a risk of electric shock from instantaneous discharge.
10. Do not remove the terminal during charging. Otherwise you may charge the internal circuit of the charger and cause malfunction.
11. Do not operate the product during charging.
12. Charging terminals should be firmly contacted during charging and should not be used if terminals are corroded or damaged.
13. When disconnecting the charger from the product, it is safe to hold the terminal without holding the wire.
14. Be sure to keep the charger disconnected from the product after the charging is complete. The charger must be disconnected if it is not used for longer than a few days, as there is a risk of overcharging when charging more than the time indicated on the product specifications.

**⚠ WARNING**

## Safety precautions for Lithium battery



- 1) **Care** Lithium batteries should be protected from direct exposure to children and pets.
- 2) **Performance**
  1. Lithium battery is affected by external temperature. In the winter, when the temperatures are low, the performance of the battery may be temporarily deteriorated and the mileage and power output is reduced.
  2. Lithium battery has a characteristic that discharge performance is reduced by more than 15% when charging / discharging 300 times or more. If usage time is shortened due to long usage, it should be replaced with a genuine one through the nearest point.
- 3) **Charging**
  1. Lithium battery should be used only with genuine battery and charger supplied from the manufacturer. Any problems caused by use of battery made by the manufacturer, mixed use, or using the charger are not covered by the manufacturer.
  2. Charging the lithium battery with a non-genuine charger may cause malfunction or fire.
  3. The lithium battery should be charged in a well-ventilated, dry place and around the charger in a place where there is no flammable material.
  4. Lithium battery should be charged at 0 ~ 45°C and discharged within -10 ~ 60°C . The sub-battery must be charged at 0 to 50°C and discharged within -20 to 75°C . Charging or discharging at a temperature outside this range may cause malfunction, fire or explosion.
  5. In case of moving from cold outside to warm indoor, please charge it after 1 ~ 2 hours. This is to prevent condensation from occurring inside the product due to the temperature difference.
- 4) **Storage**
  1. Lithium batteries should be kept away from snow, rain and direct sunlight. Do not store or charge them in a trunk or hot room. Select a dry place and store at room temperature (10 ~ 20 °C).
  2. When storing for more than 3 months, charge the remaining battery level to 70 ~ 80% (do not store full charge).
- 5) **Trouble symptom, safety**
  1. Lithium battery should be discontinued immediately if it is damaged or there is leakage of battery, sour odor, appearance deformation, etc. Please contact the place of purchase to get technical support and service.
  2. If overheat, smoke, or ignition is detected in a product with lithium battery, immediately stop charging and use, move the product outdoors as soon as possible, and then use a fire extinguisher to extinguish flames. Do not spray water or immerse the product in any situation, which can lead to more danger.
  3. Lithium battery pack has very high energy density, so if you charge the battery for a long time and there is a case of short-circuit, leakage, bad battery, etc., it can lead to ignition. Therefore, you should avoid charging for a long time without a person being present to avoid the risk of unexpected fire.
- 6) **Misuse** If the lithium battery is short-circuited, the polarity is changed, or if the battery is impacted, malfunction or fire may result. If you think that the battery has been impacted, you should stop charging and using it and visit the nearest service center for inspection.
- 7) **Water inflow** It should be controlled to prevent water inflow into the lithium battery. There is a risk of fire or electric shock if the charger is connected while moisture is present.
- 8) **Caution** Disconnect the battery from the main unit except when recharging and reinstalling. Do not use for any other purpose.
- 9) **Disposal** When disposing of the lithium battery, the battery should be separated from the product at the point of purchase or near the service center and the charge and discharge terminals are not short-circuited. Dispose of it as industrial waste.

**⚠ DANGER**

**Battery disassembly prohibited**

Battery disassembly, modification, and repair are not covered under warranty.

## Safety guidelines before driving

### 1) Required checking before use

#### 1. Check throttle and handle

- Operate the accelerator throttle lever about 2 ~ 3 times to check whether it returns to the home position.
- Be careful that excessive throttle leaning and manipulation of the throttle can cause malfunction due to internal parts damage.
- Check for free gap in the handlebars before using.



#### 2. Check brake and cable

- The brake braking force is sufficient to check the operating condition. If the braking force is significantly lowered, use it immediately after inspection and action.
- Check that the brake pad is not worn, that the cable is not loose, that the cable is not damaged, and that there is no leakage in the case of hydraulic brakes.
- If there is an unusual feeling or noise during operation, check for breakage, wear, and deformation of the inner wire of the brake cable.
- Check that the bolts and nuts of the brake fixing parts are not loose and that the disc is not deformed or damaged.



#### 3. Check tire pressure and abnormal tread wear

- Check the front and rear tires for wear and punctures and check the value marked on the surface of the tire. When the air pressure is shortened, the possibility of puncture increases, so check always.
- It is necessary to judge the replacement time by observing the appearance of the tire such as tire damage, uneven wear.



#### 4. Tightening check such as folding part and handle part

- Make sure that the bolts and nuts of all parts of the product are tight and safe from loosening. Check the fastening condition and clearance of the folding and fixing parts of the handle (folding knob, swing arm, etc. folding related parts, suspension arm bolt, swing arm bolt).



#### \* In these cases, stop driving immediately.

If you encounter any of the following situations while driving, stop driving immediately and contact your nearest branch or service center for proper measures.



If you provide pictures and videos to get an accurate diagnosis, professional counseling is available.

- Unusual heating of the motor
- Brake braking status error
- Error messages on the instrument panel
- When the throttle is not returned to its original position
- When the battery doesn't fully charge and shorter riding distance after a full charge (Battery explosion may cause due to faulty battery cell or battery cell breakdown)
- Abnormal noise is generated
- Product smoke, ignition, sour odor
- When rain or wet with water or in a similar situation
- When other driving is judged to be unreasonable

## Check and Maintenance

### Maintenance and self-maintenance

Electric products can be damaged by various factors.

The life span of each part varies depending on driving habits and driving environment.

Parts that exceed the service life may cause accidents. Let's manage various parts and prevent safety accidents in advance.

### Check the replacement timing of consumable parts

The components and suspension parts of the swing arm, tires, wheels, bearings, discs, brakepads, cables and folding parts, various brackets and other consumable parts require periodic inspection and must always be checked.



## 2. External damage inspection by driving environment



- ① Replace parts that may be damaged by the external driving environment, such as deformation of parts or tiny cracks due to pressure.
- ② If the product is exposed to strong sunlight for a long time, discoloration may occur.
- ③ In case of jumps, slight impacts such as turning, collision, etc., when driving frequently or for a long time in a poor road condition or driving for thousands of kilometers or more, fatigue breakdown phenomena may happen so please check the parts replacement schedule for each product and replace accordingly for safety.
- ④ Fatigue breakdown and maintenance parts may differ from the example conditions depending on the driving environment and the operating conditions.

Also check parts other than the replacement cycle (maintenance parts) at all times to check for any signs of abnormality.

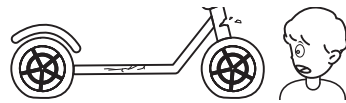

## Important check list

- \* Metal vibration may occur due to motor vibration and the vibration of the brake disc and pad during the load section that accelerates during driving. (About 15 ~ 30Km, different for each product)  
This is a phenomenon in which all rotations (fans, automobiles, ships, etc.) are vibrating at a specific rotational frequency (rpm) rather than the product. However, if the continuous noise or metal noise is large, there is a possibility that the disk will become bent and deformed.
- \* Please note that after running, there is a risk of burns due to the heat on the motor and brake (especially disk rotor) side.
- \* Be careful that the bolts of the motor, rim, and motor shaft may become loosened due to the ABS function.
- \* For inspection and repair, remove the side cover, attach the power switch, and attach it with the product's standard bolt. When tightening, carefully remove the cover of the wiring. Bolts other than the rule bolts (long bolts) can cause serious damage to the battery casing (battery cells), which can cause fire or safety accidents.
- ※ Folding parts and joints where movement occurs due to product characteristics can naturally damage the surface or paint surface during use, especially when operating in incorrect operation and form.
- ※ When inspecting the product, keep two wheels away from the ground and work on a safe workstation

**MEMO**

**MEMO**